

2024.12.04

1. N.pl. stalviršis su tiesiu borteliu 60 mm aukščio  
Stainless steel table top with 60 mm upstand

Kodas/Code  
Kiekis/ quantity  
Kaina + PVM Price

Išmatavimai (ilgis, plotis, aukštis) 253/72/4 cm  
Dimensions (length, width, height) 253/72/4 cm

GST-b-253/72/4  
1  
119,00

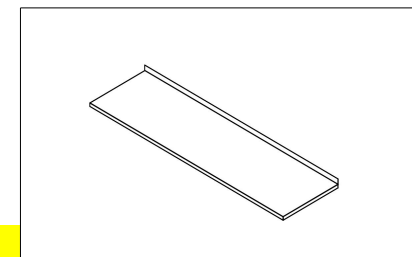

2. N.pl. stalviršis su tiesiu borteliu 60 mm aukščio  
Stainless steel table top with 60 mm upstand

Kodas/Code  
Kiekis/ quantity  
Kaina + PVM Price

Išmatavimai (ilgis, plotis, aukštis) 285/72/4 cm  
Dimensions (length, width, height) 285/72/4 cm

GST-b-285/72/4  
1  
129,00

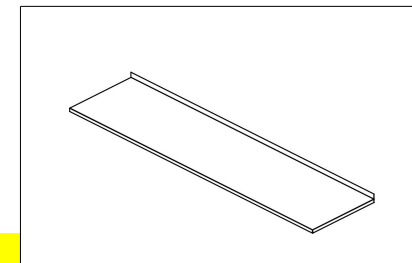

3. N. pl. stalviršis su plautuve 40/40/20 viduryje  
Stainless steel table top with sink 40/40/20 in the middle

Kodas/Code  
Kiekis/ quantity  
Kaina + PVM Price

Išmatavimai (ilgis, plotis, aukštis) 180/60/3 cm  
Dimensions (length, width, height) 180/60/3 cm

GST-P-180/60/3  
1  
139,00

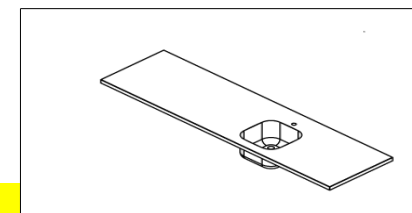

4. N. pl. stalviršis su 2 plautuvėmis 40/40/25 dešinėje ir borteliu  
Stainless steel table top with 2 sinks 40/40/25 on the right side and upstand

Kodas/Code  
Kiekis/ quantity  
Kaina + PVM Price

Išmatavimai (ilgis, plotis, aukštis) 220/60/4 cm  
Dimentions (length, width, height) 220/60/43 cm

GST-P2-b-220/60/4

1

189,00

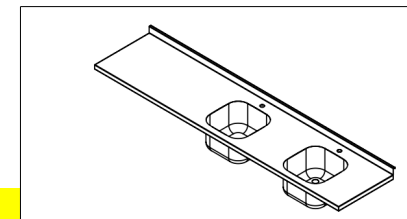

5. N. pl. stalas su rėmu ir borteliu  
Stainless steel table with frame and upstand

Kodas/Code  
Kiekis/ quantity  
Kaina + PVM Price

Išmatavimai (ilgis, plotis, aukštis) 106/60/50 cm  
Dimentions (length, width, height) 106/60/50 cm

GS-R-b-106/60/50

1

149,00

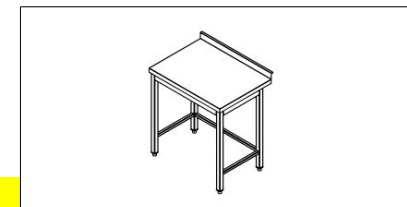

6. N. pl. stalas su plautuve 50/50/30 kairėje, su lentyna ir borteliu  
Stainless steel table with 1 sinks 50/50/30 on the left side, with shelf and upstand

Kodas/Code  
Kiekis/ quantity  
Kaina + PVM Price

Išmatavimai (ilgis, plotis, aukštis) 180/70/85 cm  
Dimentions (length, width, height) 180/70/85 cm

GS-P-09K-L-b-180/70/85

1

303,00

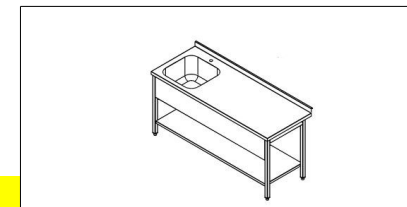

7. N. pl. stalas su plautuve 50/50/30 kairėje, su lentyna ir borteliu  
Stainless steel table with 1 sinks 50/50/30 on the left side, with shelf and upstand

Kodas/Code  
Kiekis/ quantity  
Kaina + PVM Price

Išmatavimai (ilgis, plotis, aukštis) 170/70/85 cm  
Dimentions (length, width, height) 170/70/85 cm

GS-P-09K-L-b-170/70/85

1

294,00

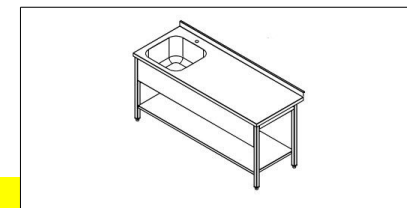

8. N. pl. stalas su plautuve 50/50/30 kairėje, su lentyna ir borteliu 50 mm  
Stainless steel table with 1 sinks 50/50/30 on the left side, with shelf and upstand 50 mm

Kodas/Code  
Kiekis/ quantity  
Kaina + PVM Price

Išmatavimai (ilgis, plotis, aukštis) 160/70/85 cm  
Dimentions (length, width, height) 160/70/85 cm

GS-P-09K-L-b-160/70/85

1

287,00

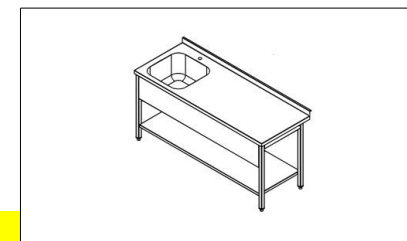

9. N. pl. stalas su plautuve 50/40/25 dešinėje, su lentyna ir borteliu  
Stainless steel table with 1 sinks 50/40/25 on the right side, with shelf and upstand

Kodas/Code  
Kiekis/ quantity  
Kaina + PVM Price

Išmatavimai (ilgis, plotis, aukštis) 200/70/85 cm  
Dimensions (length, width, height) 200/70/85 cm

GS-P-06D-L-b-200/70/90  
1  
321,00

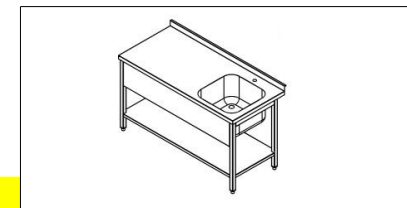

10. N. pl. stalas su 2 plautuvėmis 60/50/30, su lentyna ir borteliu H-50 mm  
Stainless steel table with 2 sinks 60/50/30, with shelf and upstand h-50 mm

Kodas/Code  
Kiekis/ quantity  
Kaina + PVM Price

Išmatavimai (ilgis, plotis, aukštis) 150/70/85 cm  
Dimensions (length, width, height) 150/70/85 cm

GS-P2-12-L-b-150/70/85  
1  
392,00

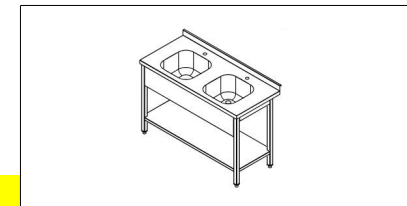

11. N.pl. pakabinama rankplovė, vidiniai kriauklės matmenys 34/34/20  
Stainless steel hand wash basin, inside dimensions 34/34/20

Kodas/Code  
Kiekis/ quantity  
Kaina + PVM Price

Išmatavimai (ilgis, plotis, aukštis) 48/48/20 cm  
Dimensions (length, width, height) 48/48/20 cm

RAN-KP-48/48/20  
1  
104,00

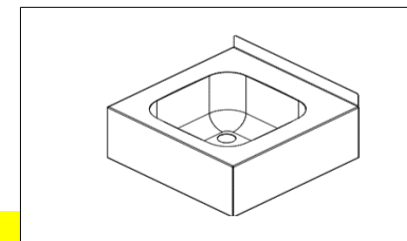

12. N.pl. stalas prie indaplovės su rėmu, užkabinimas kairėje, bortelis  
Stainless steel table by the dishwasher with a frame, left hanging,  
upstand

Kodas/Code  
Kiekis/ quantity  
Kaina + PVM Price

Išmatavimai (ilgis, plotis, aukštis) 120/70/88 cm  
Dimensions (length, width, height) 120/70/88 cm

SI-R-IK-b-120/70/88  
1  
120,00

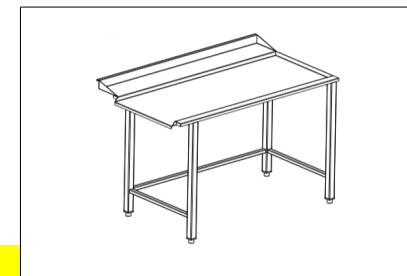

13. N.pl. stalas prie indaplovės su rėmu, su 2 plautuvėm dešinėje 50/40/30 ir borteliu  
Stainless steel table to dishwasher, with two sinks 50/40/30, upstand

Kodas/Code  
Kiekis/ quantity  
Kaina + PVM Price

Išmatavimai (ilgis, plotis, aukštis) 139/70/85 cm  
Dimensions (length, width, height) 139/70/85 cm

SI-R-P2-07-b-139/70/85  
1  
349,00

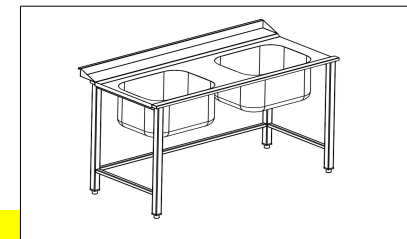

14. N.pl. stalias su rėmu, su 2 skylėmis atliekoms, diam. 250 mm, su indaploviniu borteliu  
Stainless steel table with frame, with 2 holes for waste, diam. 250 mm, with upstand

Kodas/Code  
Kiekis/ quantity  
Kaina + PVM Price

Išmatavimai (ilgis, plotis, aukštis) 130/70/88 cm  
Dimensions (length, width, height) 130/70/88 cm

GS-R-2H-b-130/70/88  
1  
190,00

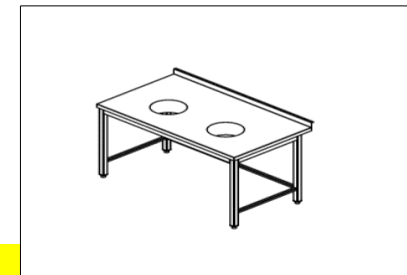

15. N. pl. pastatoma vienguba lentyna  
Stainless steel shelf table mounted

Kodas/Code  
Kiekis/ quantity  
Kaina + PVM Price

Išmatavimai (ilgis, plotis, aukštis) 100/40/30 cm  
Dimensions (length, width, height) 100/40/30 cm

LS-L1-100/40/30  
1  
60,00

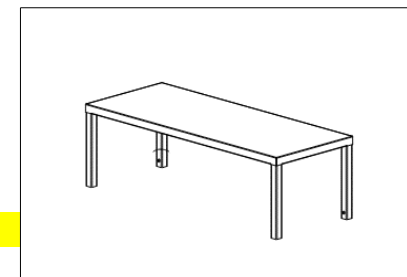

16. N. pl. pastatoma dviguba lentyna  
Stainless steel double shelf table mounted

Kodas/Code  
Kiekis/ quantity  
Kaina + PVM Price

Išmatavimai (ilgis, plotis, aukštis) 136/35/75 cm  
Dimensions (length, width, height) 136/35/75 cm

LS-L2-136/35/75  
1  
56,00

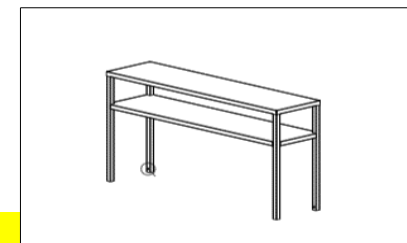

17. N.pl. pastatoma triguba lentyna  
Stainless steel shelf triple table mounted

Kodas/Code  
Kiekis/ quantity  
Kaina + PVM Price

Išmatavimai (ilgis, plotis, aukštis) 100/90/90 cm  
Dimensions (length, width, height) 100/90/90 cm

LS-L3-100/90/90  
1  
75,00

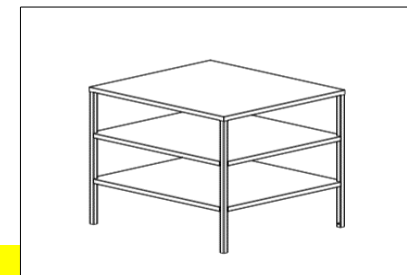

18. N.pl. Stelažas 4 pastiprintų lentynų  
Stainless steel rack 4 reinforced shelves

Kodas/Code  
Kiekis/ quantity  
Kaina + PVM Price

Išmatavimai (ilgis, plotis, aukštis) 200/60/180 cm  
Dimensions (length, width, height) 200/60/180 cm

STV-Lps4-200/60/180  
1  
350,00

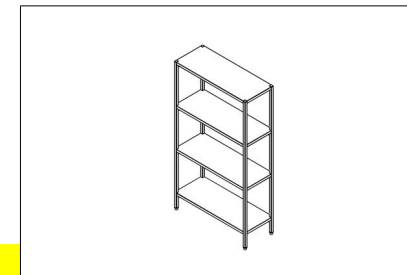

19. N.pl. pakabinama lentyna universali  
Stainless steel universal shelf

Kodas/Code  
Kiekis/ quantity  
Kaina + PVM Price

Išmatavimai (ilgis, plotis, aukštis) 130/40/18 cm  
Dimensions (length, width, height) 130/40/18 cm

NG-LPU-130/40/18  
1  
55,00

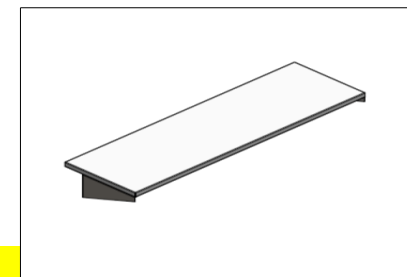

20. N.pl. stovas konvekcinei krosniai su 6-iomis kreipiančiosiomis  
Stainless steel rack for convection oven with 6 rails

Kodas/Code  
Kiekis/ quantity  
Kaina + PVM Price

Išmatavimai (ilgis, plotis, aukštis) 85/67,5/55 cm  
Dimensions (length, width, height) 130/40/18 cm

SK-GN6-85/67,5/55  
5  
100,00

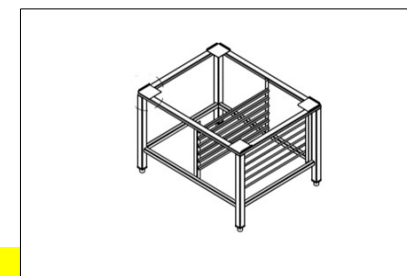

21. N. pl. rėmas su lentyna  
Stainless steel frame with shelf

Kodas/Code  
Kiekis/ quantity  
Kaina + PVM Price

Išmatavimai (ilgis, plotis, aukštis) 150/80/80 cm  
Dimensions (length, width, height) 150/80/80 cm

NG-R-L-150/80/80  
1  
59,00

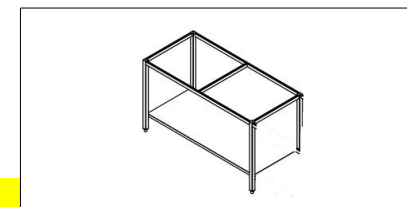

**22. N. pl. trapas**  
**Stainless steel drain**

**Išmatavimai (ilgis, plotis, aukštis) 24/24/22 cm**  
**Dimentions (length, width, height) 24/24/22 cm**

**Kodas/Code**  
**Kiekis/ quantity**  
**Kaina + PVM Price**

**KT-24/24/22**  
**10**  
**89,00**

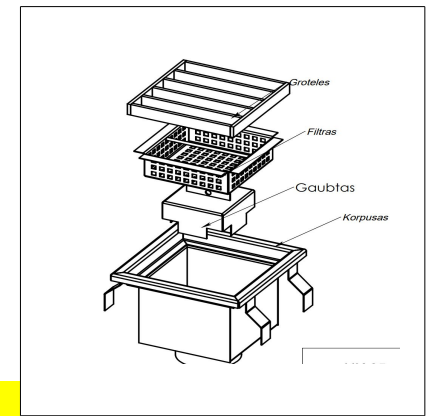

**Dėl turimų gaminių kreiptis nurodytais kontaktais**  
**For available products, please contact by contacts below**

E-mail: [request@ukrenga.lt](mailto:request@ukrenga.lt), [sales@ukrenga.lt](mailto:sales@ukrenga.lt), [sales3@ukrenga.lt](mailto:sales3@ukrenga.lt)  
Mob. Tel. +370 645 74871